

# FPS-210

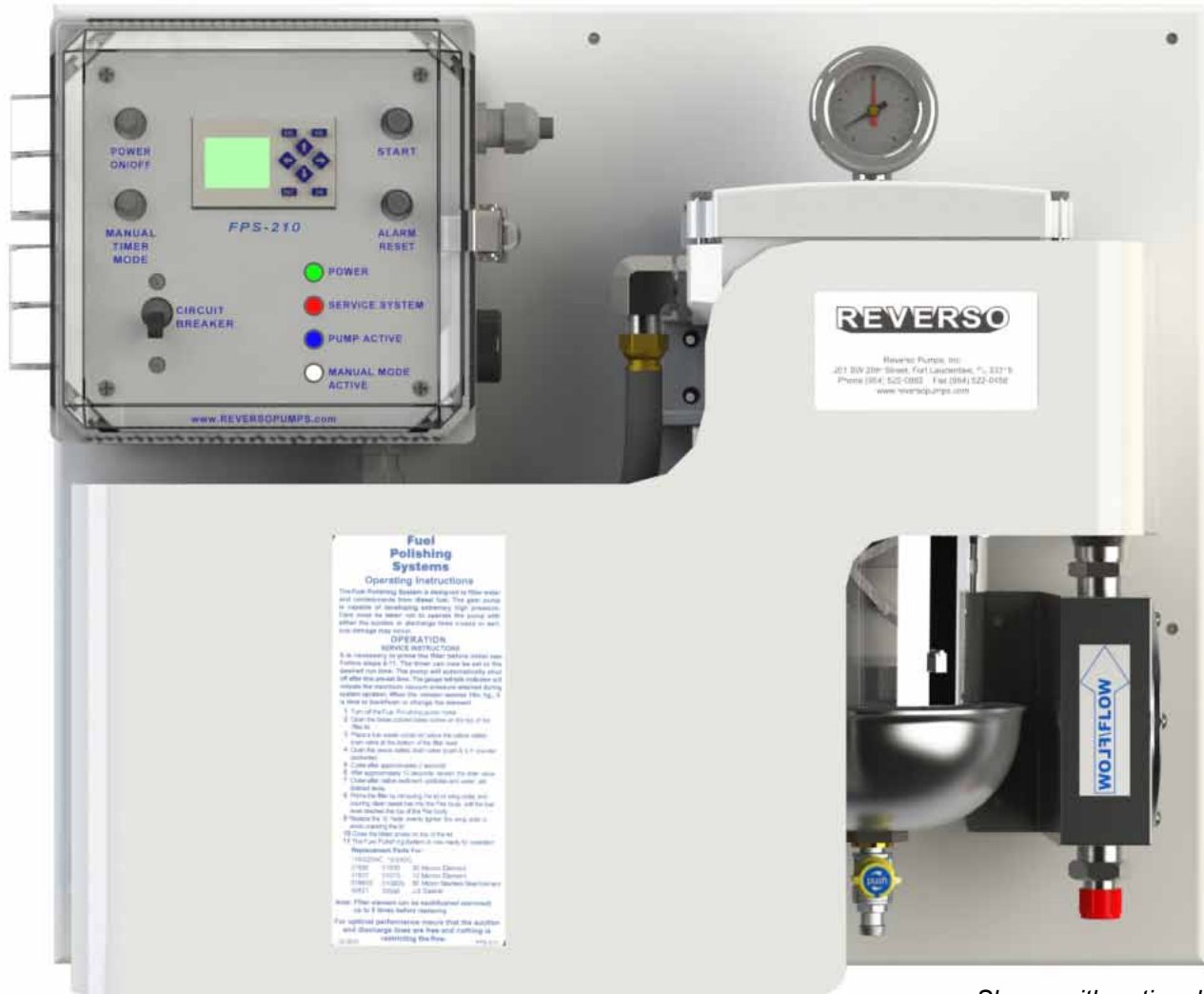

*Shown with optional magnetic fuel conditioner*

## Table of Contents

System Overview.....	3
Control Panel Overview.....	4
Dimensions.....	5
Technical Specifications .....	6
Primary Inspection, Installation, & Electrical Installation .....	7
Initial Setup.....	8
Digital Timer Instructions: Set Date and Time .....	9
Digital Timer Instructions: Set Schedule Timer.....	10
Digital Timer Instructions: Set Manual Timer.....	11
Digital Timer: Alarms.....	12
Backflushing Instructions.....	13
Filter Element Replacement .....	14
Spare Parts.....	15
Troubleshooting.....	16

- 1 Control panel
- 2 Cover
- 3 Vacuum gauge
- 4 Fuel water separator - model SWK-2000/18
- 5 Base
- 6 Fuel conditioner (optional)
- 7 Inlet - 1/2" Male JIC
- 8 Drain valve - *Push in and turn counter-clockwise to open*
- 9 Pump and Outlet (not shown, under cover) - 1/2" Male JIC

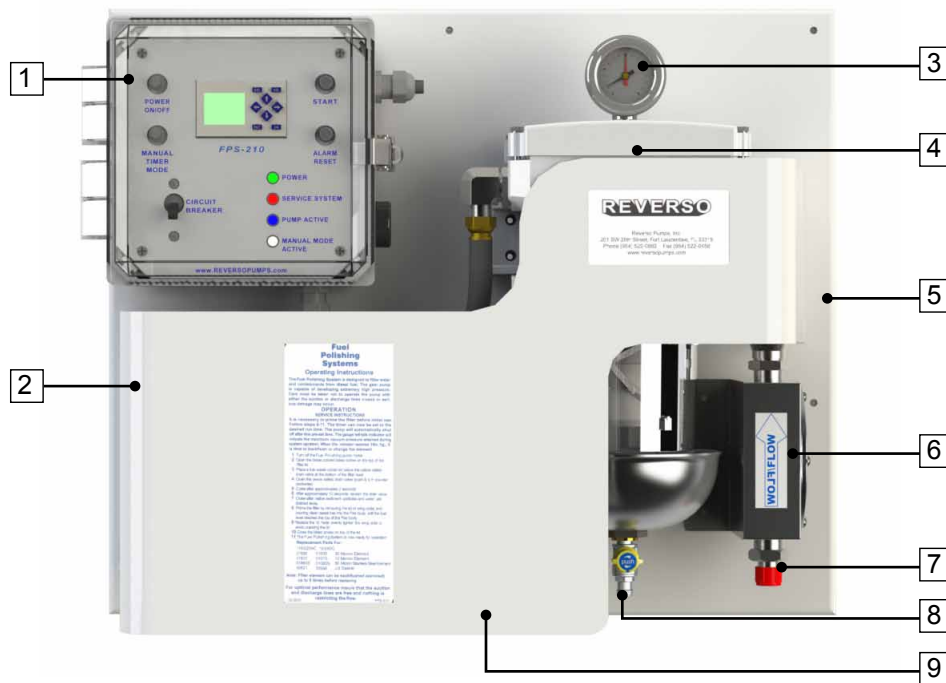

## Control Panel

- Control Panel**
1. Power button
  2. Digital timer
  3. Manual timer mode button
  4. Circuit breaker
  5. Start button
  6. Alarm reset button
  7. Power on light - *indicates when system is on*
  8. Service system light - *indicates an alarm has been triggered and user must service the system*
  9. Pump active light - *indicates fuel polishing system is running*
  10. Manual timer mode active light - *indicates system is operating in manual timer mode (not schedule timer mode)*
- Digital Timer**
11. Left key
  12. Up key
  13. Right key
  14. Down key
  15. OK key
  16. Escape key

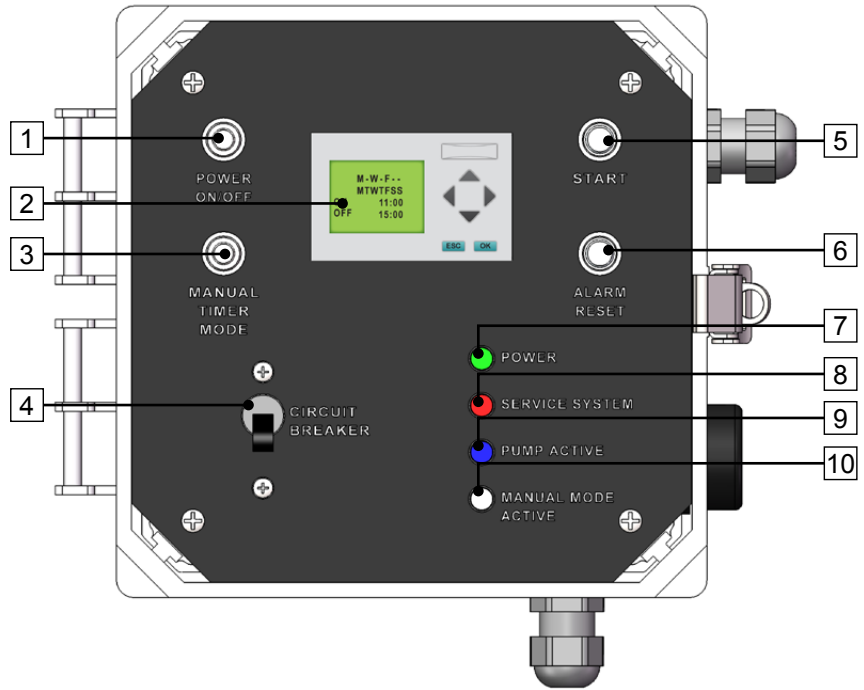

## Digital Timer

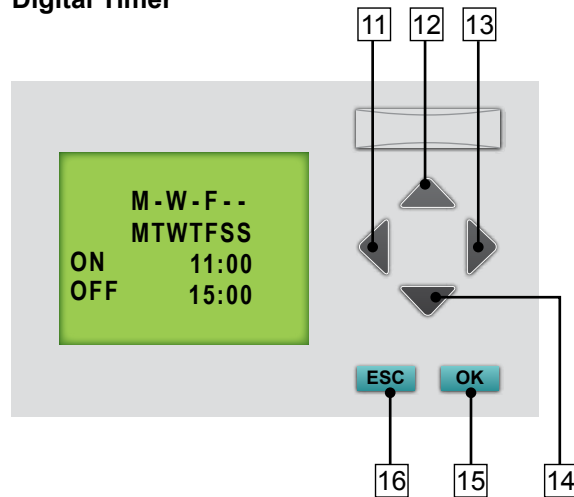

Part #: 21-1944-01

All Dimensions for Reference Only  
Secondary Dimensions in Millimeters

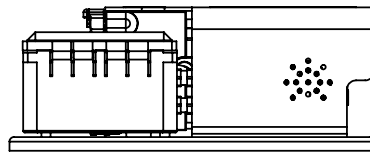
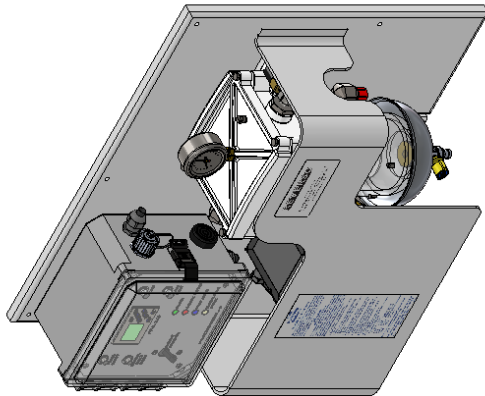
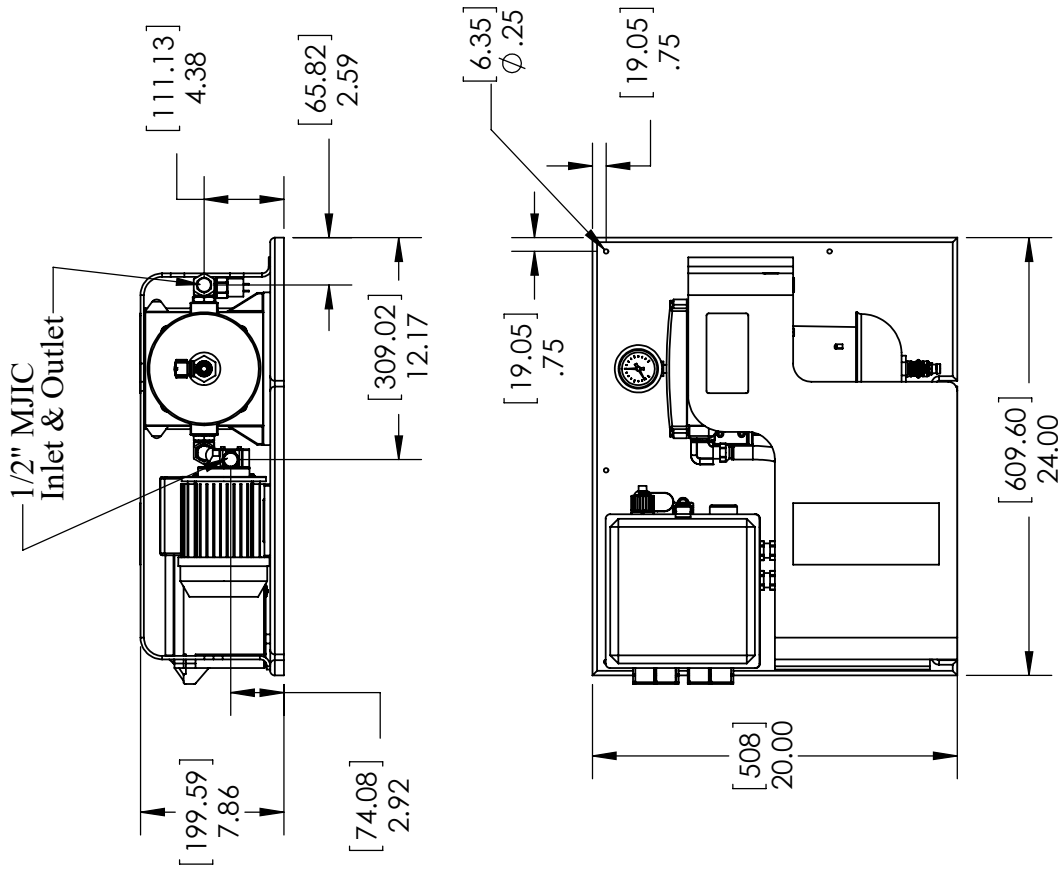

**TECHNICAL SPECIFICATIONS**

Port Size - 1/2" #8 Male JIC  
Lift - 30 ft. / 9m  
Power - AC 110 volt / 10 Amp  
Flow Rate - 210 GPH / 795 LPH

**PROPRIETARY AND CONFIDENTIAL**

THE INFORMATION CONTAINED IN THIS DRAWING IS THE SOLE PROPERTY OF REVERSO PUMPS. ANY REPRODUCTION IN PART OR AS A WHOLE WITHOUT THE WRITTEN PERMISSION OF REVERSO PUMPS IS PROHIBITED.

**UNLESS OTHERWISE SPECIFIED:**

DIMENSIONS ARE IN INCHES  
TOLERANCES:  
FRACTIONAL ±1/64  
ANGULAR ±.01  
TWO PLACE DECIMAL ±.01  
THREE PLACE DECIMAL ±.005  
DO NOT SCALE DRAWING

NAME	DATE	REVERSO PUMPS	
DRAWN JC	10/12/2018	TITLE: FPS210S32-01 - Fuel Polishing System - 7 Day Digital Timer - 110 volt - 10 Amp - 210 Series - 'S' Class	
CHECKED JC	10/12/2018	SIZE A	REV A
ENG APPR.		DWG. NO. FPS210S32-01-ER-R_	
MFG APPR.		SCALE: 1:10	WEIGHT: SHEET 1 OF 1
Q.A.		COMMENTS:	

Flow Rate	Approximately 210 GPH (795 LPH). Actual flow rate may vary due to conditions of installation.	
Operating Temperature	40 - 104°F (4-40°C)	
Amp. Draw	3A@110V, 1.2A@220V	
Circuit Breaker	10A@110V, 10A@220V	
Service Space	4" on top and bottom, to facilitate changing filter elements and draining water and particulate from the bowl	
Pump	Brass Gear stainless shaft- double lip seal	
Maximum Suction Hose	32.8 ft / 10m with foot valve above liquid level	
Maximum Delivery Hose	164 ft / 50m	
Maximum Level Difference	Between pump and suction: from 5 - 9.8 ft maximum / 1.5 to 3 m maximum. Between pump and highest point of delivery: 23 ft / 7m maximum	
Timer	Digital PLC	
Inlet	1/2" Male JIC	
Outlet	1/2" Male JIC	
Max Fluid Viscosity	29 CST	
Filter Torque Values	Bowl Retainer Ring	8 Nm (70 in-lbs)
	Lid	8 Nm (70 in-lbs)
	Plug	15 Nm (130 in-lbs)
	Bleed Screw	4 Nm (35 in-lbs)

## Warning

- The system has been developed to be used with diesel fuel only, **DO NOT USE WITH GASOLINE.**
- The system is designed to meet environmental standards for safe operation (NOT for use with fluids that have a flash point below 100°F (38°C), e. g.: Gasoline, alcohol,...)

## Primary Inspection

- Upon delivery inspect the FPS (Fuel Polishing System) for any damage that may have occurred during shipment.
- Inspect the interior of the unit for mechanical or electrical damage.
- If the unit is damaged upon delivery, contact the shipping company immediately.

## Mounting

- The FPS should be wall mounted on a hard, vertical surface capable of supporting the weight of the unit.
- The control electronics are enclosed in a NEMA 4 weather proof box and will withstand being located outside.
- In all cases the unit should be located as close as possible to the tank being serviced. (see Max. Lift in Technical Specifications).
- When installing the unit below the level of the fuel on above ground fuel tanks, consideration should be made to the installation of an anti-syphon valve to prevent fuel spillage in the case of a leak in the piping system.

## Electrical

- **Installation of unit should only be performed by qualified installation personnel who have thoroughly read and understands the installation instructions covered in this manual.**
- **To avoid the risk of electric shock, make sure that the power supply is disconnected. Ensure that the power supply is at zero volts with a multimeter before making any electrical connections.**
- **To ensure operator safety the FPS must be connected to properly grounded power sources.**
- Make sure that your unit and power supply are configured for the same voltage rating.
- External control voltage must be supplied by customer.

## Piping

Use quality approved fuel line materials with at least 1/2" inner diameter line. Smaller plumbing will place excessive load on the motor and shorten its life. A full port ball valve should be installed on the inlet and outlet ports of the FPS.

The pickup line(s) (suction) should originate from the lowest point of the tank and should be connected directly to the inlet. For optimal performance, ensure that this line is free and nothing is restricting flow. It is recommended to install a foot valve to keep the system primed, especially if the system is located above the lowest possible fuel level in the tank.

If the FPS is mounted below tank top level, a priming tee should be installed on the highest point of the suction line to be able to easily prime the systems suction line.

The return line(s) (discharge) should be connected to the outlet and enter the tank as far as possible from the pick up tube and extending 2/3 down into the tank. For optimal performance, ensure that the outlet, discharge or return, line(s) are free and nothing is restricting their flow.

**The suction line of the FPS must be independent and separate from the suction line of the engine. Do not integrate into engine fuel system.**

**When installing this unit, FLEXIBLE CONNECTIONS MUST BE USED TO REDUCE STRESS on the plumbing and prevent damage to the unit.**

Hoses, piping, solenoid valves and foot valves shown in the diagrams below are not provided with the system and must be provided by the user/contractor, unless agreed upon otherwise.

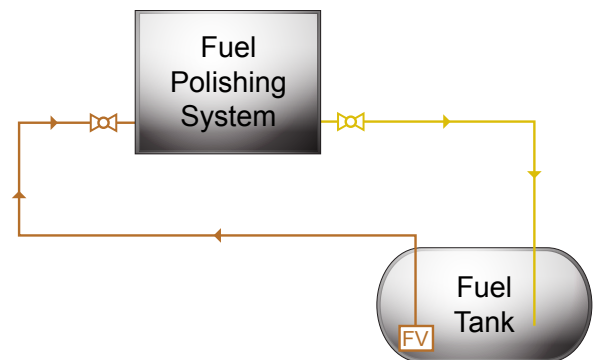
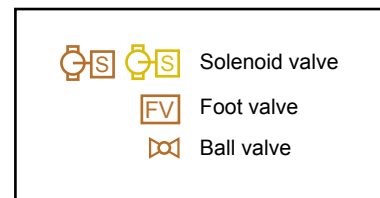

1

Open the fuel supply valve.  
Prime fuel system and  
check for leaks.

2

Set gauge pressure indicator  
(red needle) slightly to the  
left of the black needle prior  
to operation.



The gauge will indicate  
maximum vacuum pressure  
during system operation.

3

If the system is equipped with a **mechanical timer**, turn timer knob clockwise to desired number of hours for operation. If the system is equipped with a **digital timer**, choose timer mode if available. You may have previous version (circular digital timer).

### Manual Timer Mode

Operate in this mode if system will run one set time.

- Must press manual timer mode button to activate / deactivate.
- Manual timer mode light will be ON.
- Pump will start upon pressing the start button.
- Pump will automatically shut off after the preset run time.

### Schedule Timer Mode

Operate in this mode if system will start/stop automatically on the programmed days of the week and times.

- Must press manual timer mode button to activate / deactivate.
- Manual timer mode light will be OFF.
- Pump will automatically start and stop according to the preset date and time.

4

Press start button.  
Power on indicator will be lit.

If in manual timer mode, pump will immediately begin running.

If in schedule timer mode, pump will only begin running if within programmed date/time to run.

Verify the pump is operating by checking vacuum gauge located on the filter. Gauge will be reading 0-5 in-Hg of vacuum.

5

When the indicator reaches  
15 in-Hg, it is time to drain or  
change the filter element.

The same procedure is  
necessary if the water level  
reaches 30% of the clear bowl.





# Digital Timer Instructions: Set Date and Time

1

Starting at the program screen, press DOWN key to view current time screen.

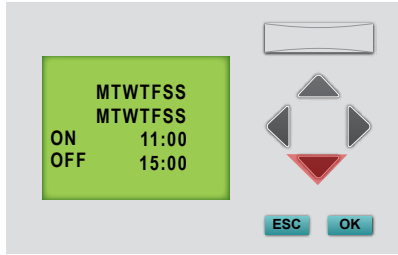

2

The current date and time is displayed. Time is shown as 24 hr clock. Date is shown YYYY-MM-DD. Press ESC key.

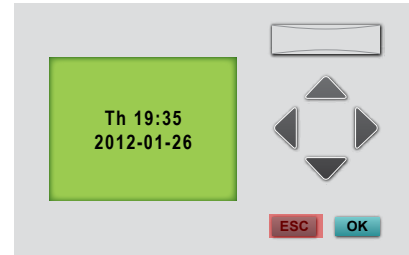

3

Use the DOWN arrow to move the cursor to Set.. option. Press OK key to continue.

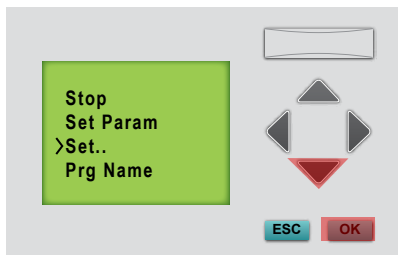

4

Select Clock.. option. Press OK key to continue.

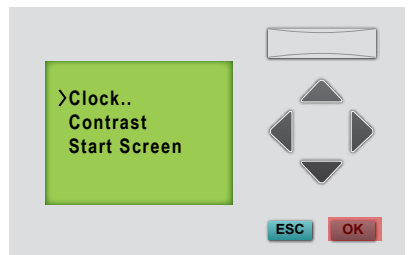

5

Select Set Clock option and press OK key to continue.

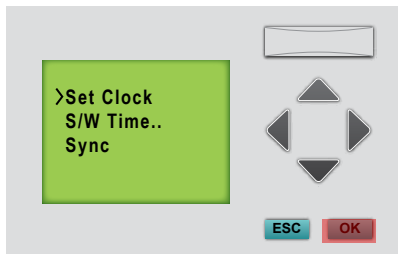

6

Flashing black box indicates your selection. Use LEFT/RIGHT key to move selection. Use UP/DOWN key to change date and time. Press OK key when finished and to return to previous menu.

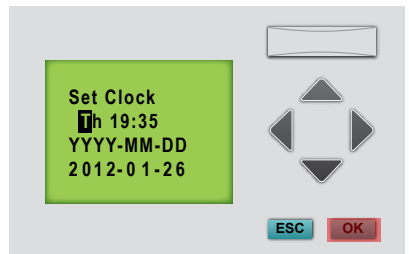

7

Press ESC key. Press ESC key again to return to current time screen.

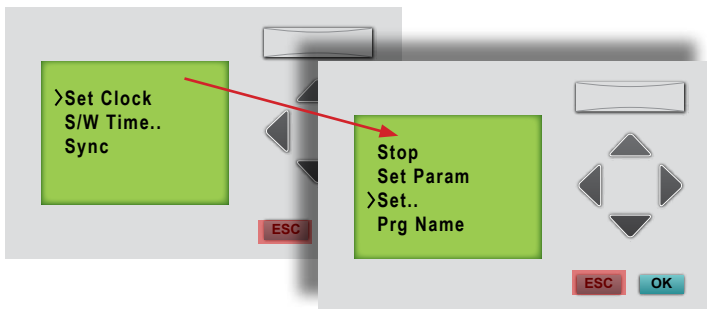

8

Now shown is the current time screen. Press UP key to return to program screen.

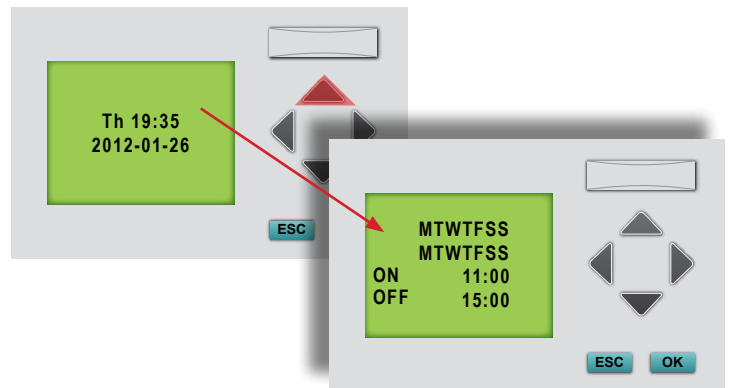

# Digital Timer Instructions: Set Schedule Timer

**1** *When using this method, follow sequence exactly or damage to program can occur (non-warrantable situation).*

- A. Ensure the breaker is ON.
- B. Move the red power switch to the ON position and power indicator light is on.
- C. Ensure timer mode is switched to Schedule Timer.

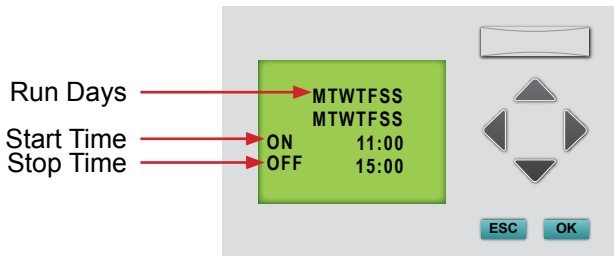

**2** Hold the ESC key until flashing underline appears under the first day of the week. This flashing underline indicates your selection. Use the LEFT/RIGHT keys to move between the dates, start time, and stop time.

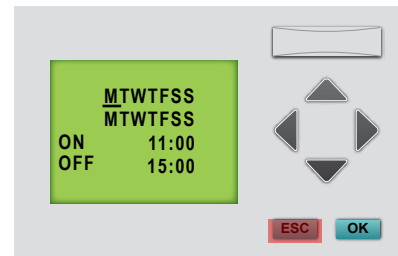

**3** **Change the run days**  
With the flashing underline in the days row, press the OK key until flashing box appears. Use the LEFT/RIGHT key to move between days. Use the UP/DOWN key to program run days. A dash(-) indicates the system will not run on that day. Press OK key when finished and the cursor will return to flashing underline.

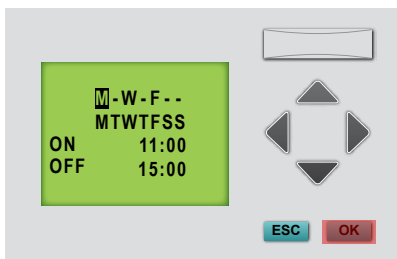

**4** **Change the run time**  
With the flashing underline in the days row, use the LEFT/RIGHT key to move to start time (ON). Press OK key until flashing box appears. Use UP/DOWN key to change time. Press OK key when finished and the cursor will return to flashing underline. Repeat with stop time (OFF).

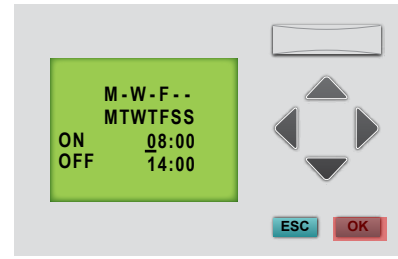

**5** Press ESC to save. Flashing underline will disappear.

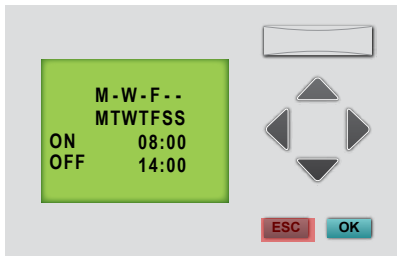

**6** Setting the schedule timer is finished. In this example, system will run on Monday, Wednesday and Friday. System will start at 8:00 am and stop at 2:00 pm.

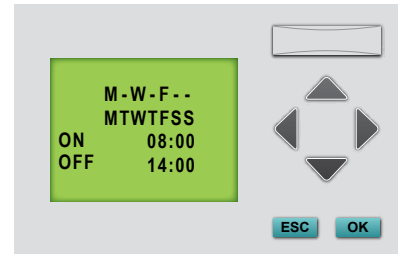

**7** Every 5 seconds, screen will request user to push Start button to activate program.

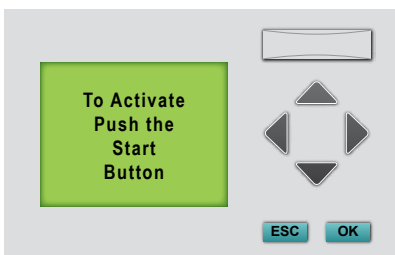

**8** Afterwards, every 5 seconds screen will indicate the schedule timer is active.

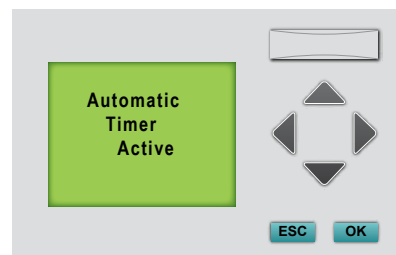

# Digital Timer Instructions: Set Manual Timer

1

Top row indicates current time.  
Bottom row indicates program time.

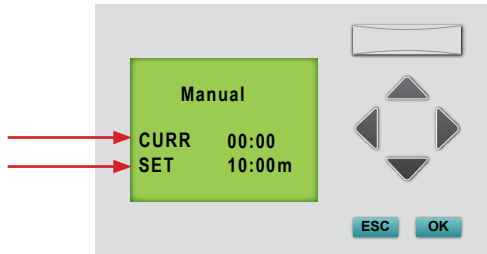

2

Press and hold ESC key until flashing underline appears. This indicates your selection. Use RIGHT arrow key to move between move underline to program time (SET).

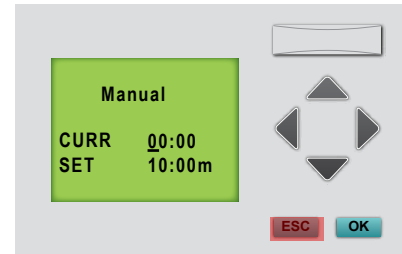

3

Use RIGHT arrow key to move underline to program time (SET).

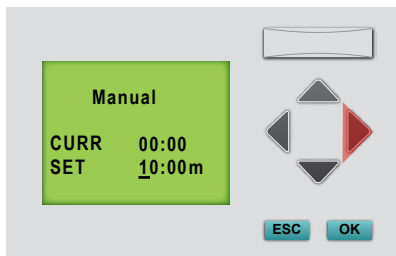

4

Press OK key and flashing box appears. Use UP/DOWN key to change time. The "m" indicates minutes and can be changed to "h" for hours. When finished, press OK key.

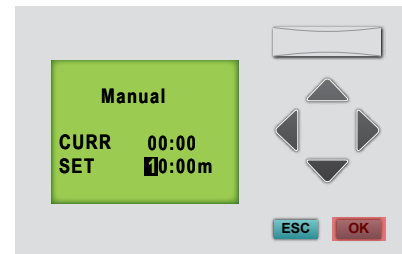

5

Flashing box will return to flashing underline. Press ESC to save. Flashing underline will disappear.

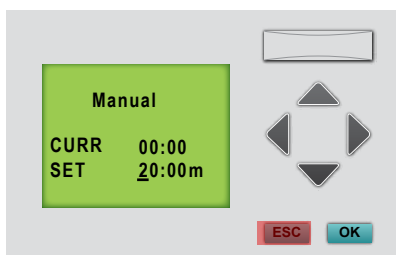

6

In the screen shown below, the system is set to run for 20 minutes and will stop once the time has expired.



There are three different alarms installed in the unit.

If one of the alarms should sound: De-energize system when servicing unit.

1. Follow the directions displayed on the screen.
2. Press RESET/STOP button
3. Wait at least 2 minutes, then press START to restart the unit.

If you have successfully cleared the alarms, the unit should restart.

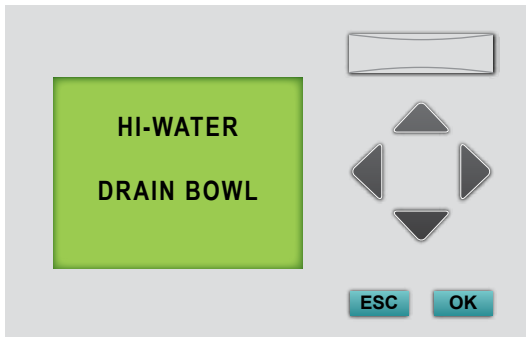

## High Water Alarm

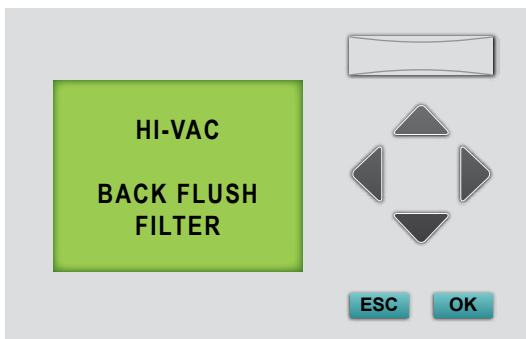

## High Vacuum Alarm

Backflushing procedure can be executed up to 5 times before replacing the filter element.

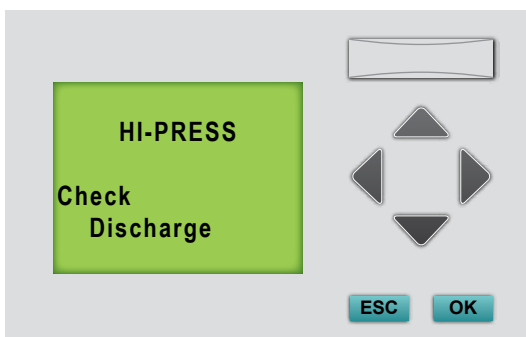

## High Pressure Alarm

Prior to service, ensure the system is off.

Backflushing is for particulate removal only and will not remove sludge once embedded in the filter media.

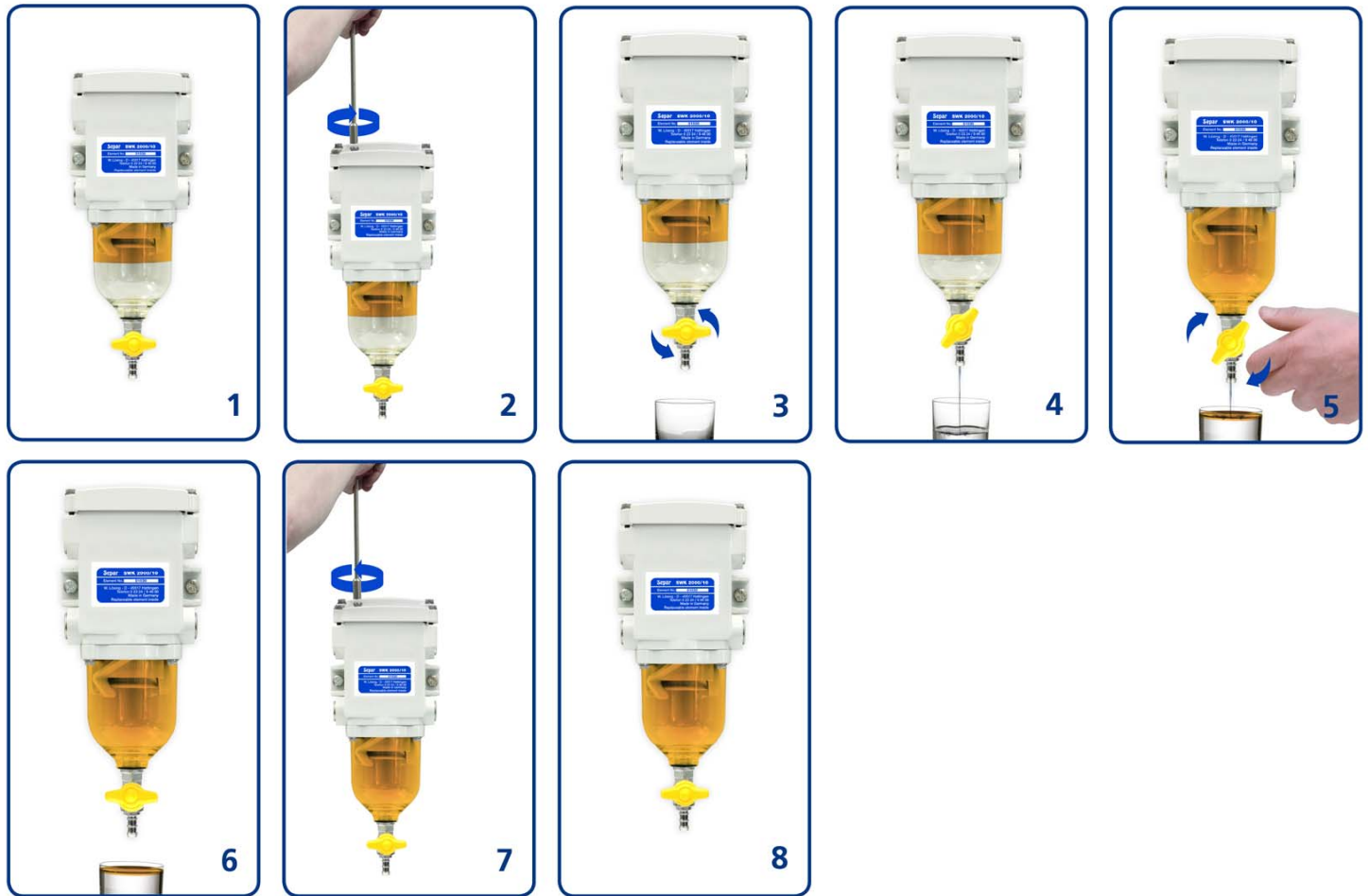

Prior to service, ensure the system is off.

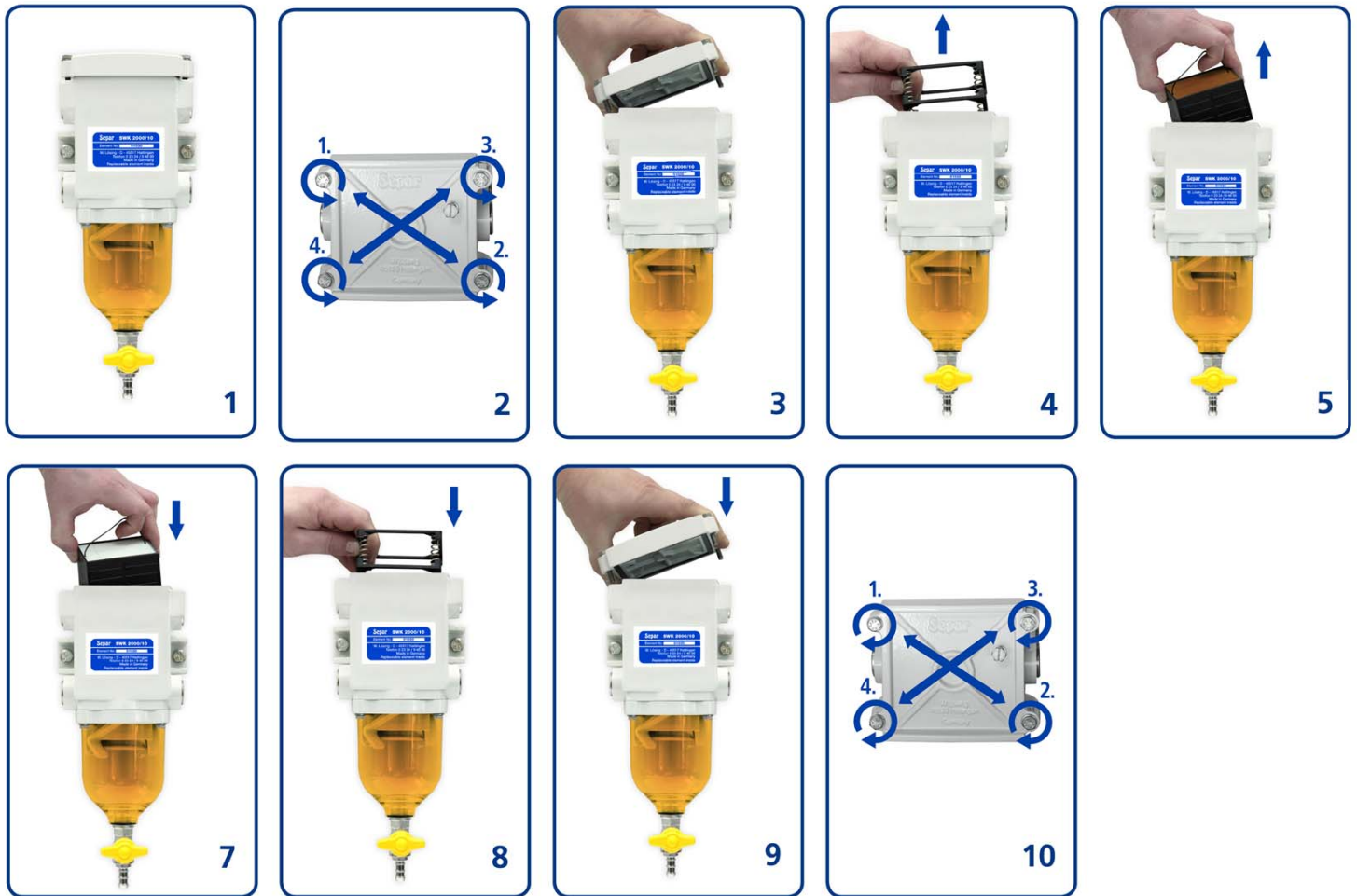

## Replacement Filter Element

Element #	Description
01810	10 Micron
01830	30 Micron (Standard)
01860S	60 Micron (Stainless Steel)

Part #	Description	Category
59-01810	10 micron element, 1 piece	Separ Filter Model SWK-2000/18
59-01810-12	10 micron element, 1 case contains 12 pieces	
59-01830	30 micron element, 1 piece	
59-01830-12	30 micron element, 1 case contains 12 pieces	
59-01830S	60 micron element, stainless	
65-30421	Lid gasket	
65-30423	Bowl gasket	
65-30979	Seal kit	
16-30404	Hex Bolt Kit: (4) lid hex bolts, (4) bowl hex bolts, (8) washers, and (4) o-rings for lid hex bolts	
16-30408	Bleed screw	
65-30353	Drain valve	
65-30572-01-02	White lid, tapped (gauge, bleed screw, and lid gasket sold separately)	
65-30298	Spring frame	
80-3146	Replacement pump	Pump
11-3109	Driving gear	
11-3108	Idle gear	
11-3111	Key	
11-31110	O-ring for cover plate	

Problem	Possible Causes
<b>No fuel delivery</b>	<ul style="list-style-type: none"> <li>• Pump does not run</li> <li>• Pump and filter are not primed</li> <li>• Fuel supply or discharge line blocked. Check the alarm</li> <li>• Lift is too high</li> <li>• Air leak in fuel supply to pump</li> <li>• Inlet or outlet valve closed. Check the solenoid valve</li> <li>• Foot (check) valve installed backwards</li> </ul>
<b>Insufficient fuel delivered</b>	<ul style="list-style-type: none"> <li>• Air leak at inlet</li> <li>• Lift too high</li> <li>• Pump worn</li> <li>• Inoperative foot valve</li> <li>• Piping improperly installed or dimensioned</li> <li>• Filter/water separator plugged</li> </ul>
<b>Rapid pump wear</b>	<ul style="list-style-type: none"> <li>• Pump has been run dry or insufficient fuel</li> <li>• Plumbing on inlet side not appropriately dimensioned. Pump requires too much power</li> <li>• Air in plumbing lines</li> <li>• Liquid too viscous</li> </ul>
<b>Noisy operation</b>	<ul style="list-style-type: none"> <li>• Insufficient fuel supply</li> <li>• Air leaks in the inlet pipe</li> <li>• Air or gas on the suction side</li> </ul>
<b>Motor does not turn or turns intermittently</b>	<ul style="list-style-type: none"> <li>• Control power not available</li> <li>• Tripped circuit breaker on control board</li> <li>• Pump failed and seized</li> <li>• Motor failure</li> <li>• Check service switch is in the ON position ( - )</li> </ul>
<b>Pump leaks fuel</b>	<ul style="list-style-type: none"> <li>• Loose pump plumbing fittings</li> <li>• Worn pump shaft seal</li> <li>• Excessive heat from over head storage tank</li> <li>• Worn pump O-rings or seals</li> </ul>